

PSI NATURAL GAS ENGINE
GENERATING SETS
MAINTENANCE AND
USER MANUAL

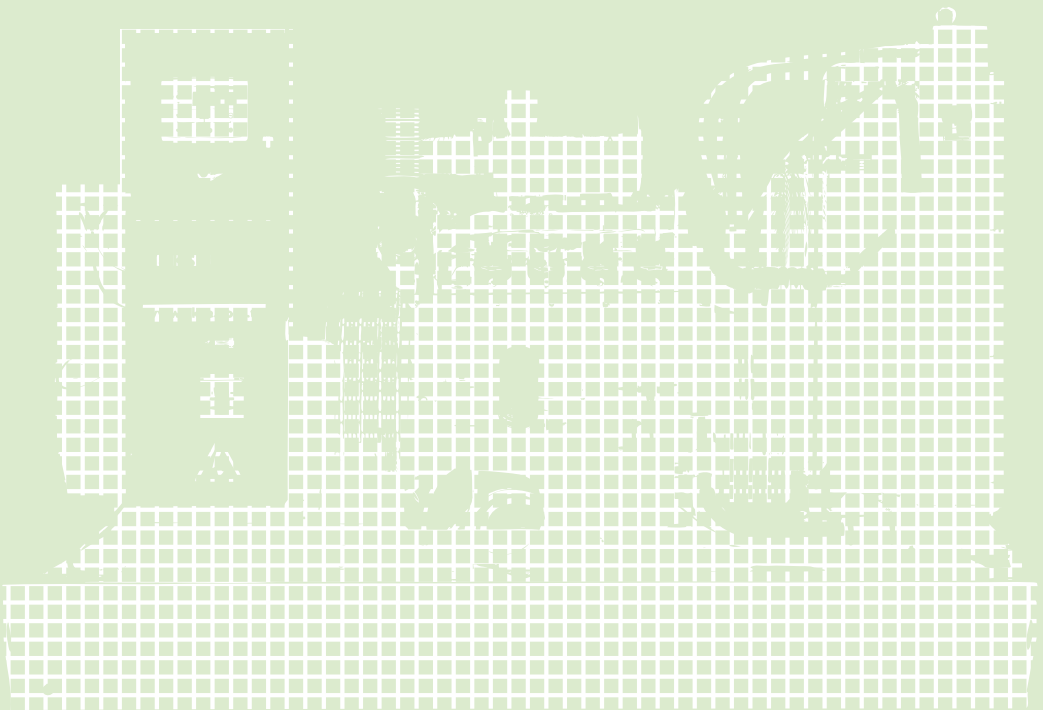

PSI NATURAL GAS ENGINE
GENERATING SETS
MAINTENANCE AND USER
MANUAL

HEAD OFFICE

AKSA JENERATÖR SAN. A.Ş.

Rüzgarlıbahçe Mah. Özalp Çıkması No:10

34805, Kavacık - Beykoz / İSTANBUL

T : +90 216 444 4 630

F : +90 216 681 57 81

aksa@aksa.com.tr

AUTHORIZED SERVICE

AKSA SERVICE & SPARE PARTS

Muratbey Beldesi, Güney Girişi Caddesi

No: 8 34540 Çatalca / İSTANBUL

T: +90 212 887 11 11

F: +90 212 887 10 20

info@aksaservis.com.tr

DEAR AKSA GENERATOR SET USERS

Thank you for purchasing this quality-built Aksa Natural Gas Generator. When operated and maintained according to the instructions in the operator's manual, your Aksa generator will provide many years of dependable service.

This manual is designed and developed to make you familiar with the generating system. Please read the following instructions carefully before starting to use your machine.

This manual contains safety information to make you aware of the hazards and risks associated with generator systems and how to avoid them.

Never operate, maintain or repair your generating set without taking general safety precautions.

The manufacturer reserves the right to change, alter or otherwise improve the system at any time without prior notice.

akSa
J E N E R A T Ö R

1.	INTRODUCTION	1
2.	GENERAL SAFETY PRECAUTIONS.....	2
2.1.	General.....	2
2.2.	Handling.....	2
2.3.	Fire and Explosion.....	2
2.4.	Mechanical.....	3
2.5.	Chemical.....	3
2.6.	Noise.....	3
2.7.	Electrical.....	3
2.8.	First Aid For Electric Shock.....	4
3.	GENERAL DESCRIPTION.....	5
3.1.	Generator Set Description And Identification.....	5
3.2.	Generator Set Main Parts.....	5
3.3.	Natural Gas Engine.....	6
3.4.	Engine Electrical System.....	6
3.5.	Cooling System.....	6
3.6.	Synchronous Alternator.....	6
3.7.	Coupling.....	6
3.8.	Base Frame.....	6
3.9.	Vibration Isolation.....	6
3.10.	Silencer And Exhaust System.....	6
3.11.	Control System.....	6
4.	ELECTRIC STARTING SYSTEM.....	7
4.1.	Battery Systems.....	7
4.2.	Maintenance Batteries.....	7
4.3.	Battery Maintenance.....	7
4.4.	Maintenance Free Batteries.....	7
4.5.	Control of the Battery.....	7
4.6.	Starting Aids.....	7
5.	HEALTHY AND SAFETY.....	7
5.1.	Fire Protection.....	7
5.2.	Exhaust Gases.....	8
5.3.	Moving Parts.....	8
5.4.	Hazardous Voltages.....	8
5.5.	Water.....	9
5.6.	Coolant.....	9

6.	WATER TREATMENT	9
6.1.	General.....	9
6.2.	Engine Coolant.....	9
7.	LUBRICATING OIL	9
7.1.	Oil Performance Properties	9
7.2.	Lubrication Oil Recommendations for Doosan Engines.....	9
8.	General precautions and controls which must be done before starting up the generating set....	12
9.	GENERATING SET CONTROL SYSTEMS	12
9.1.	Control Panel.....	12
9.1.1.	Control System P 612	12
9.1.2.	Control System P 732	13
10.	General precautions and controls which must be done after starting up the generating set.....	14
11.	GENERATING SET MAINTENANCE	15
11.1.	Maintenance Schedule For Gen-set.....	15
12.	ENGINE TROUBLESHOOTING	20
13.	ALTERNATOR DESCRIPTION	20
13.1.	General.....	20
13.2.	Construction and Components	20
13.3.	Operation	20
13.4.	Automatic Voltage Regulator	21
14.	VENTS AND DUCTS	21
15.	MECCALTE ALTERNATOR TROUBLESHOOTING	22
16.	STORAGE OF THE GENERATOR	22
16.1.	Storage	22
16.2.	Preparing for Operation After Storage.....	22
	General precautions about warranty	

ATTACHMENTS

- AKSA JENERATÖR AUTHORIZED SERVICE POINTS
- AKSA JENERATÖR WHERE TO BUY ABROAD
- CERTIFICATIONS
- WARRANTY CERTIFICATE

1. INTRODUCTION

Aksa Generating set is designed to be commissioned, when delivered, as soon as the necessary cooling water, antifreeze, gas fuel, lubrication oil and fully charged battery are provided. With its long years of experience, Aksa manufactures efficient; reliable and quality generating set. This user and maintenance manual is prepared to assist the operator in operation and maintenance of the generating set. Observing the advices and rules in this manual will ensure that the generating set operates in maximum performance and efficiency for a long time.

- Care should be taken to perform more frequent maintenance in dirty and dusty environments in order to keep the generating set in good working condition,
- Necessary adjustment and repairs should be made only by authorized and qualified persons.
- Each generating set has a model and a serial number indicated on a label on the base frame. This plate also indicates the manufacturing date, voltage, current power in kVA, frequency, power factor and weight of the generating set. These data are necessary in spare part orders, for warranty validity and for service calls.

Attach unit to base-frame with suitable diameter masonry anchor bolts long enough to retain the unit.

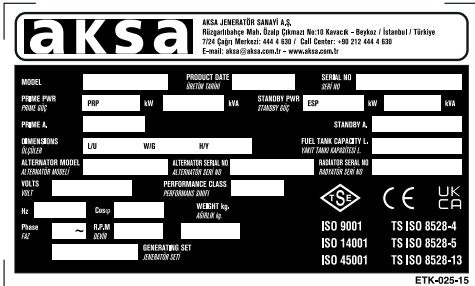

The generating set is designed to be safe when used in correct manner. However responsibility for safety rests with the personnel who install use and maintain the set. If the following safety precautions are followed, the possibility of accidents will be minimized. Before performing any procedure or operating technique, it is up to the user to ensure that it is safe.

The generating set should only be operated by personnel who are authorized and trained.

Only people that have the right skills should be allowed to operate, adjust, perform maintenance or repair on Aksa Power Generation equipment. It is the responsibility of management to appoint operators with the appropriate training and skill for each category of job.

Skill level 1: Operator

An operator is trained in all aspects of operating the unit with the push- buttons, and trained to know the safety aspects.

Skill level 2: Mechanical technician

A mechanical technician is trained to operate the unit the same as the operator. In addition, the mechanical technician is also trained to perform maintenance and repair, as describe in the instruction manual, and is allowed to change settings of the control and safety system. A mechanical technician does not work on live electrical components.

Skill level 3: Electrical technician

An electrical technician has the same qualifications as both the operator and the mechanical technician. In addition, the electrical technician may carry out electrical repairs within the various enclosures of the unit. This includes work on live electrical components.

Skill level 4: Specialist from the manufacturer

This is skilled specialist sent by the manufacturer or its agent to perform complex repairs or modifications to the equipment. In general it is recommended that not more than two people operate the unit, more operators could lead to unsafe operating conditions. Take necessary steps to keep unauthorized person away from the unit and eliminate all possible source of danger at the unit.

The manufacturer does not accept any liability for any damage arising from the use of non-original parts and for modifications, additions or conversions made without the manufacturer's approval in writing.

2. GENERAL SAFETY PRECAUTIONS

2.1. GENERAL

1- The owner is responsible for maintaining the unit in a safe operating condition. Unit parts and accessories must be replaced if missing or unsuitable for safe operation.

2- Operate the unit only for the intended purpose and within its rated limits (pressure, temperature, speeds, etc).

3- Gen-set and equipment shall be kept clean, i.e. as free as possible from oil, dust or other deposits.

4- To prevent an increase in working temperature, inspect and clean heat transfer surfaces (cooler fins, intercoolers, water jackets, etc.) regularly.

5- Take precautions against fire. Handle gas fuel, oil and anti-freeze with care because they are inflammable substances. Do not smoke or approach with naked flame when handling such substances. Keep a fire-extinguisher in the vicinity.

WARNING

! Read and understand all safety precautions and warnings before operating or performing maintenance on the generating set.

! Failure to follow the instructions, procedures, and safety precautions in this manual may increase the possibility of accidents and injuries.

! Do not attempt to operate the generating set with a known unsafe condition.

! If the generating set is unsafe, put danger notices and disconnect the battery negative (-) lead so that it cannot be started until the condition is corrected.

! Disconnect the battery negative (-) lead prior to attempting any repairs for cleaning inside the enclosure.

! Install and operate this generating set only in full compliance with relevant National, Local or Federal Codes; Standards or other requirements.

2.2. HANDLING

The following safety precautions should be noted:

WARNING

! Make electrical connections in compliance with rele-

vant Electrical Codes; Standards or other requirements. This includes requirements for grounding and ground/earth faults.

! Engine exhaust emissions are hazardous to personnel. The engine exhaust for all indoor generating sets must be piped outdoors via leak-free piping in compliance with relevant Codes, Standards and other requirements. Ensure that hot exhaust silencers and piping are clear of combustible material and are guarded for personnel protection per safety requirements. Ensure that fumes from the exhaust outlet will not be a hazard

! Never lift the generating set by attaching to the engine or alternator lifting lugs, instead use the lifting points on the base flame or canopy.

! Ensure that the lifting rigging and supporting structure is in good condition and has a capacity suitable for the load.

! Keep all personnel away from the generating set when it is suspended.



2.3. Fire and Explosion

Warning

- Natural Gas is extremely flammable and explosive.
 - Fire or explosion can cause severe burns or death.
 - Install the gas fuel supply system according to applicable fuel-gas codes.
 - Before placing the generator into service, the fuel system lines must be properly purged and leak tested.
 - After the generator is installed, you should inspect the gas fuel system periodically.
 - NO leakage is permitted.
 - DO NOT operate engine if smell of fuel is present or other explosive conditions exist.
 - DO NOT smoke around the generator. Wipe up any oil spills immediately. Ensure that no combustible materials are left in the generator compartment. Keep the area near the generator clean and free of debris.
- However, safety dictates that fully charged BC and ABC fire extinguishers are kept on hand. Personnel must know how to operate them.



WARNING

! Ensure that the generating set room is properly ven-

tilated.

! Keep the room, the floor and the generating set clean. When spills of oil, battery electrolyte or coolant occur; they should be cleaned up immediately.

! Do not smoke or allow sparks, flames or other sources of ignition around gas line or batteries.

! Turn off or disconnect the power to the battery charger before making or breaking connections with the battery.

! To avoiding arcing keep grounded conductive objects (such as tools) away from exposed live electrical parts (such as terminals).

2.4. Mechanical

The generating set is designed with guards for protection from moving parts. Care must still be taken to protect personnel and equipment from other mechanical hazards when working around the generating set

WARNING

! Do not attempt to operate the generating set with the safety guards removed. While the generating set is running do not attempt to reach under or around the guards to do maintenance or for any other reason.



! Keep hands; arms, long hair; loose clothing and jewelry away from pulleys, belts and other moving parts.

Attention: Some moving parts cannot be seen clearly when the set is running.

! If equipped keep access doors on enclosures closed and locked when not required to be open.

! Avoid contact with hot oil, hot coolant hot surfaces and sharp edges and corners.

! Wear protective clothing including gloves and hat when working around the generating set.

! Do not remove the radiator filler cap until the coolant has cooled.

Then loosen the cap slowly to relieve any excess pressure before removing.



2.5. Chemical

Oils, coolants, lubricants and battery electrolyte used in this generating set are typical of the industry. However, they can

be hazardous to personnel if not treated properly.

WARNING

! Do not swallow or allow skin contact with oil, coolant lubricants or battery electrolyte. If swallowed, seek medical treatment immediately.

! Do not wear clothing that has been contaminated by lube oil.

! Wear an acid resistant apron and face shield or goggles when servicing the battery.

If electrolyte is spilled on skin or clothing flush immediately with large quantities of water.



2.6. Noise

Generating sets that are not equipped with sound attenuating enclosures can produce noise levels in excess of 105 dB(A). Prolonged exposure to noise levels above 85 dB(A) is hazardous to hearing.



WARNING

Ear protection must be worn when operating or working around an operating generating set.

2.7. Electrical

Effective and safe operation of electrical equipment, it is only ensured by the correct placement, use and maintenance of equipment.

WARNING

! The generating set must be connected to the load only by trained and qualified electricians who are authorized to do so, and in compliance with relevant Electrical Codes, Standards and other regulations.

! Ensure that the generator set is effectively earthed/grounded in accordance with all relevant regulations before starting.

! The generating set should be shutdown with the battery negative (-) terminal disconnected prior to attempting to connect or disconnect load connections.

! Do not attempt to connect or disconnect load connections while standing in water or on wet or soggy ground.

! Do not touch electrically energized parts of the generating set and/or interconnecting cables or conductors with any part of the body or with any non insulated conductive object.



! Replace the generating set terminal box cover as soon as connection or disconnection of the load cables is complete. Do not operate the generating set without the cover securely in place.

! Connect the generating set only to loads and/ or electrical systems that are compatible with its electrical characteristics and that are within its rated capacity.

! Keep all electrical equipment clean and dry. Replace any wiring where the insulation is cracked, cut abraded or otherwise degraded, Replace terminals that are worn, discolored or corroded. Keep terminals dean and tight

! Insulate all connections and disconnected wires.

! Use only Class BC or Class ABC extinguishers on electrical fires.

2.8. First Aid For Electric Shock

WARNING

! Do not touch the victim's skin with bare hands until the source of electricity has been turned off.

! Switch off power if possible otherwise pull the plug or the cable away from the victim.

! If this is not possible, stand on dry insulating material and pull the victim clear of the conductor, preferably using insulated material such as dry wood.

! If victim is breathing, moving the victim away from conductor, preferably using insulated material such as dry wood.

! If victim is breathing, turn the victim into the recovery position described below. If victim is unconscious, perform resuscitation as required;

Open the airway

Tilt the victim's head back and lift the chin upwards. Remove objects from the mouth or throat (including false teeth, tobacco or chewing gum).



Breathing

Check that the victim is breathing by looking, listening and feeling for the breath.



Circulation

Check for pulse in the victim's neck.

If no breathing but pulse is present

- Pinch the victim's nose firmly.
- Take a deep breath and seal your lips around the victim's lips.
- Blow slowly into the mouth watching for the chest to rise.
- Let the chest fall completely.

Give breaths at a rate of 10 per minute.

• If the victim must be left to get help, give 10 breaths first and then return quickly and continue.

• Check for pulse after every 10 breaths. When breathing restarts, place the victim into the recovery position described later in this section.



If no breathing and no pulse

- Call or telephone for medical help.
- Give two breaths and start chest compression as follows:



• Place heel of hand 2 fingers breadth above ribcage/breastbone junction.

• Place other hand on top and inter-lock fingers,

• Keeping arms straight, press down 4-5 cm at a rate of 15 times per minute.



• Repeat cycle (2 breaths and 15 compressions) until medical help takes over.

• If condition improves, confirm pulse and continue with breaths.

Check for pulse after every 10 breaths.



• When breathing restarts, place the victim into the recovery position described below.

Recovery position

- Turn the victim onto the side.
- Keep the head tilted with the jaw forward to maintain the open airway.
- Make sure the victim cannot roll forwards or backwards.

• Check for breathing and pulse regularly. If either stops, proceed as above.



WARNING

! Do not give liquids until victim is conscious.

3. GENERAL DESCRIPTION

3.1. Generating Set Description and Identification

Natural gas generators are independent units for the production of electric power basically; they comprise a constant voltage synchronous driven by a gas engine. The sets are used for two main purposes;

a- Continuous duty sets,

Used to produce electric power for countless requirements (motive power, lighting heating etc) in areas where other sources or power are unavailable.

b- Emergency duty sets,

Used during public network failures, when such failures are liable to cause serious trouble to persons or material or financial damage (i.e. in hospitals, industrial plants with non-stop operating cycles, etc) or to meet peak energy demands.

According to their application, the sets are further divided into:

- set for use on land

The sets for use on land can be

- stationary sets (fixed installation),

These sets are available in a vast range of versions, for every operating requirement the main ones being:

01. hand control generating sets
02. stand-by generating sets

The standard stationary generating set comprises;

- natural gas engine
- synchronous generator
- coupling
- metal sub-base with vibration isolators
- starter batteries
- instrument panel
- exhaust gas silencer.

Aksa Generating Set has been designed as a complete package to provide superior performance and reliability. Figure. 3.1. identifies the major components. This figure is of atypical generating set. However, every set will be slightly different due to the size and configuration of the major components. This section briefly describes the parts of the generating set. Further in-

formation is provided in later sections of this manual. Each generating set is provided with a Rating Label (item 1) generally fixed to the base frame. This label contains the information needed to identify the generating set and its operating characteristics. This information includes the model number, serial number, output characteristics such as voltage and frequency, output rating in kVA and kW, product date and weight.

The model and serial numbers uniquely identify the generating set and are needed when ordering spare parts or obtaining service or warranty work for the set. Aksa generating sets are an Alternating Current generator, built for continuous running at sites where no electricity is available (some models are excepted) or as stand-by in case of interruption of the mains.

The generator operates at 50 Hz 230/220 V. in line-to-neutral mode and 400/380 V in line-to-line mode.

3.2. Generating Set Main Parts

Figure 3.1. Typical Engine Generator Set

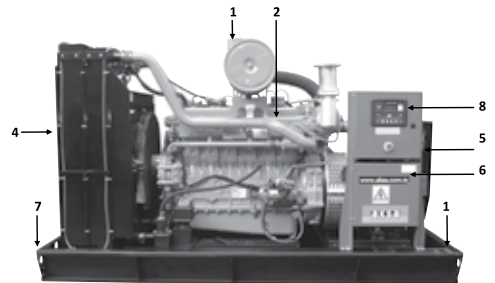

No	Description
1	Aksa Generating Set Rating Label
2	Natural Gas Engine
3	Air Filter
4	Radiator
5	Alternator
6	Terminal Box
7	Base Frame
8	Control Panel

3.3. Natural Gas Engine

The natural gas engine powering the generating set (Item 2) has been chosen for its reliability and the fact that it has been specifically designed for powering generating sets. The engine is of the heavy duty industrial type with 4 stroke and is fitted with all accessories to provide a reliable power supply. These accessories include, among others, a cartridge type dry air filter (item 3) and an electronic engine speed governor. The engine cylinder block is cast in one piece cast iron, vertical cylinders inline overhead valves and camshaft in block. The cylinder head is made of special cast iron. The thermally loaded flame plate is efficiently water cooled. The crankshaft is forged in one piece in a high tensile steel.

Lubrication: forced lubrication via gear pump, special paper cartridge -type filters, lubricant cooling via heat exchanger on most versions.

3.4. Engine Electrical System

The engine electrical system is 24 VDC negative ground/earth. This system includes an electric engine starter, a battery and a battery charging alternator. For 24 volts electrical system two batteries are given. Other types of batteries may be fitted if they were specified.

3.5. Cooling System

The engine cooling system is water cooled. The water cooled system is comprised of a radiator (Item 4) a pusher fan and thermostat. The alternator has its own internal fan to cool the alternator components.

3.6. Synchronous Alternator

Horizontal axle alternator (synchronous three phase), on rolling bearings, self-ventilated within the room with low-loss silicon-sheet stator bundle, electrolytic copper winding with class H insulation.

The output electrical power is normally produced by a screen protected and drip-proof, self-exciting, self-regulating, brushless alternator. (Item 5) Fine tuned to the output of this generating set. Mounted on top of the alternator is a sheet steel terminal box (Item 6).

3.7. Coupling

Engine and alternator are firmly joined by a coupling cone that guarantees the proper assembly coaxiality. Mono-support machines are also used a special flexible disk is used in place of a flexible coupling.

3.8. Base frame

The engine and alternator are coupled together and mounted on a heavy duty steel base-frame (Item 7).

3.9. Vibration Isolation

The generating set is fitted with vibration isolators which are designed to reduce engine vibration being transmitted to the foundation on which the generating set is mounted. These isolators are fitted between the engine /alternator feet and the base frame.

3.10. Silencer and Exhaust System

Exhaust gases from the turbocharger are discharged toward atmosphere through a silencer. These should be vented as high as possible, and must be prevented from re-entering the engine via the charge air intake, or polluting the radiator fins.

It is important to note that the turbocharger nozzles must be always free of loads. Stainless steel exhaust compensator(s) is delivered with generator set. Exhaust lines of different engines shall not be mixed in a common stack, but routed separately in individual ducts, enclosed in a chimney.

Suitable material is carbon steel sheet, and recommended calculation temperature is 475°C. Rain and condensate permanent draining shall be provided to prevent water entering the silencer and the engine.

An exhaust silencer is provided loose for installation with the generating set. The silencer and exhaust system reduce the noise emission from the engine and can direct exhaust system reduce the noise emission from engine and can direct exhaust gases to safe outlets. The exhaust silencer is made of a carbon steel receiver containing sound attenuator and wave de-phasing system made of perforated steel sheet and heavy rock wool. It is asbestos-free. The exhaust silencer is delivered in two configurations with an industrial attenuation and residential attenuation.

3.1.1. Control System

One of several types of control systems and panels (item 8) may be fitted to control the operation and output of the set and to protect the set from possible malfunctions. Section 1.1 of this manual provides detailed information on these systems and will aid in identification of the control system fitted on the generating set.

4. ELECTRIC STARTING SYSTEMS

Electric starting systems are generally used on all gen-sets.

The power source for electric starting systems is a 24VDC battery system. Control of starting is via a start solenoid which is controlled by the gen-set control system.

4.1. Battery Systems

Battery type is lead acid. Lead acid batteries are generally used, being the least expensive.

4.2. Maintenance Batteries

Warning

- Do not smoke or allow sparks, flames or other sources of ignition around batteries. Hydrogen gas generated by charging batteries is explosive.
- Wear an acid resistant apron and face shield or goggles when servicing the battery. If electrolyte is spilled on skin or clothing, flush immediately with large quantities of water.
- Take out the metallic things in your wrist and protect your wrist and hand.
- Disconnect the battery negative (earth) lead first and reconnect last.
- Always ensure that battery charging is carried out in a well ventilated area.

The starting batteries should be located as close as possible to the generating set while still being accessible for servicing. This will prevent electrical losses.

4.3. Battery Maintenance

- Keep the top of the battery and its terminals clean.
- Cover the battery terminals and its connections with Vaseline.
- Tighten the terminals but not tighten it hardly.

- Control the electrolyte level periodically. It must be 10 mm above the plates.
- Control the abrasion in the charge alternator belt and check periodically the belt tension according to producer' recommendation.
- Ensure that your battery is not uncharged.

4.4. Maintenance Free Batteries

Ensure that all battery connections are correct and batteries are always charged. After that there is not any procedure for this battery.

4.5. Control of the Battery

Conduct an inspection every time before testing the battery.

1. A white powdered element causes abrasion to the pole-heads, its connections. Remove the connections and wash them with hot water to purify the oxidation. Reconnect it and coat with vaseline.
2. Check if any un-tightened connections exist.

4.6. Starting Aids

It is customary to maintain coolant temperatures above 40°C min. to promote quick starting on an emergency generating set and to take the load. Thermostatically controlled immersion heaters, deriving their supply from the primary source of power are fitted in the engine cooling system to provide this heating. Heater warms up the jacket water of the engine when the generating set is not working.

5. HEALTHY and SAFETY

Safety should be the primary concern of the facility design engineer and all personnel engaged on installation and commissioning. Safety involves two aspects:

- 1) Safe operation of the generator itself (and its accessories).
- 2) Reliable operation of the system.

Reliable operation of the system is related to safety because equipment affecting life and health, such as life support equipment in hospitals, emergency aggress lighting, building ventilators, elevators and fire pumps, may depend on the generator set.

5.1. Fire Protection

The design, selection and installation of fire protection systems require the following considerations:

- The fire protection system must comply with the requirements of National Standards.
- Typically, the generator room will be required to have a one hour fire resistance rating. Generator room construction will have to have a two hour fire resistance rating.
- Generator room shall not be used for storage purposes.
- The authority may specify the quantity, type and sizes of approved portable fire extinguishers required for the generator room.
- A manual emergency stop station outside the generator room or enclosure or remote from the generator set in an outside enclosure would facilitate shutting down the generator set in the event of a fire or another type of emergency.

General

- Do not permit any flame, cigarette, pilot light, spark, arcing equipment, or other ignition source near the generating set or fuel line.
- Fuel lines must be adequately secured and free of leaks. Fuel connection at the engine should be made with an approved flexible line.
- Be sure all fuel supplies have a positive shut-off.

5.2. Exhaust Gases

- Be sure the exhaust system will properly dispel discharged gases a way from enclosed or sheltered areas and areas where individuals are likely to congregate.
- Never connect the exhaust system of two or more engines.
- Never discharge engine exhaust into a brick, tile or cement block chimney, or a similar structure. Exhaust pulsations could cause severe structural damage.
- Do not use exhaust gases to heat a compartment.
- Be sure that the unit is well ventilated.
- Ensure that there is independent support for the exhaust system. No strain should be imposed on the engine exhaust manifolds. Which is especially important on a turbo-charged engine.

5.3. Moving Parts

- Tighten supports and keep guards in position over fans drive belts etc. Make sure that fasteners on the set are secure.
- Keep hands, clothing and jewellery away from moving parts.
- If adjustment must be made while the unit is running, use extreme caution around hot manifolds, moving parts, etc.

5.4. Hazardous Voltages

Improper wiring can cause fire or electrocution, resulting in severe personal injury or death and property or equipment damage.

For personal protection, stand on a dry wooden platform or rubber insulating mat, make sure clothing and shoes are dry, remove jewellery from hands and use tools with insulated handles.

- Do not leave cables trailing on the engine room floor.
- Do not use the same trunking for electric cables and water lines.
- Do not run AC and DC cables in the same looms or trunking
- Always ensure that bonding and equipment earthing are correctly done. All metallic parts that could become energised under abnormal conditions must be properly earthed.
- Always disconnect the batteries and battery charger when serving or carrying out maintenance particularly on equipment arranged for automatic mains failure operation. Always disconnect a battery charger from its AC source before disconnecting the battery cable. Accidental starting of the generator set while working on it can cause severe personal injury or death.
- Do not tamper with interlocks.
- Do not connect the generator set directly to any building electrical system.
- Always follow all applicable state and local electrical codes. Have all electrical installations performed by a qualified licensed electrician.

High voltage sets work differently to low voltage ones. Special equipment and training is required to work around high voltage equipment. Operation and maintenance must be done only by persons trained and qualified to work on such devices. Improper use or

procedures may well result in personal injury or death.

- Do not work on energised equipment. Unauthorised personnel must not be permitted near energised equipment. Due to the nature of high voltage electrical equipment includes voltage remains after the equipment is disconnected from the power source. Equipment should be de-energised and safety earthed.

5.5. Water

Water or moisture inside a generator increases the possibility of "flashing" and electrical shock, which can cause equipment damage and severe personal injury or death. Do not use a generator which is not dry inside and out.

5.6. Coolant

The coolant heater must not be operated while the cooling system is empty or when the engine is running or damage to the heater will occur. Coolant under pressure have a higher boiling point than water.

- Do not open a radiator, pressure cap while the engine is running. Allow the generator set to cool and bleed the system pressure first.

6. WATER TREATMENT

6.1. General

The engine cooling system is subject to rust and cavitation attacks. To minimize the severity of this condition an anti-corrosive agent can be added to totally clean and limpid coolant water.

An antifreeze solution is also required to prevent freezing of the coolant in the cold weather.

6.2. Engine Coolant

Water for coolant should be clean and free from any corrosive chemicals such as chlorides, sulphates and acids. It should be kept slightly alkaline with a pH value in the range 8,5 to 10,5.

Generally, any water which is suitable for drinking can be used, with treatment as described below.

Protection against corrosion

Supplemental Coolant Additive is required to protect the cooling system from fouling, solder blooming and general corrosion.

The use of antifreeze is also recommended as DCA4: A corrosion inhibitor concentrations are dependent upon the presence of antifreeze. Antifreeze also interacts with DCA4: A corrosion inhibitor to provide greater corrosion and cavitation protection.

Procedure for Treating Coolant

1. Add the required amount of water to mixing con-

tainer and dissolve in the required quantity of DCA4: A corrosion inhibitor

2. Add the required amount of antifreeze, if used, to the water solution and mix thoroughly.

3. Add the coolant to the cooling system

Cold Weather Protection

Antifreeze must be added to the coolant where there is any possibility of freezing to protect the engine from damage due to coolant freezing.

The engine cooling water can be used diluting it with antifreezing solution 40% and the additive for rust prevention (DCA4) 3 ~ 5 %. The dosage of DCA4 must be increased to higher concentration if antifreeze is not added to the coolant A low - silicate antifreeze is recommended.

The density of antifreezing solution and additive for rust prevention is able to be confirmed by the cooling water test kit

- Amount of Anti-freeze in winter

Ambient Temperature (°C)	Cooling water (%)	Anti-freeze (%)
Over- 10	85	15
-10	80	20
-15	73	27
-20	67	33
-25	60	40
-30	56	44
-40	50	50

7. LUBRICATING OIL

Oil system of diesel engine is one of the most important elements of the engine. Correctly made engine overhaul (this subject includes oil change periods, filter change periods, paying attention about selecting the true type of oil) prolongs the life cost of the engine.

7.1. Oil Performance Properties

The American Petroleum Institute (API) the American Society for Testing and Materials (ASTM) and Society of Automotive Engineers (SAE) has developed and preserved a system in order to classify the lubrication oils for their performance categories.

7.2. Engine Oil Recommendation for PSI

Multi-viscosity oils are recommended. SAE 10W-30 is recommended for your engine from 0 degrees F (-18 degrees C) or above. If ambient temperatures are consistently below 0 degrees F, SAE 5W-30 oil can be used. Synthetic oils are not required for industrial or stationary engines.

- Engine oil should be changed at the specified inter-

vals. Oil and the oil filter cartridge should be changed according to below recommendation.

7.3. Changing Engine Oil and Filter

The engine oil and filter must be changed every 150 hours or every 3 months whichever occurs first.

Under normal operating conditions, you do not need to change them more often if you use oil and filters of the recommended quality.

The oil and filter should be changed more often if the engine is operating in dusty or extremely dirty areas, or during cold weather. No oil additives or break-in oil change is required.

Engine oil viscosity - ambient temperature

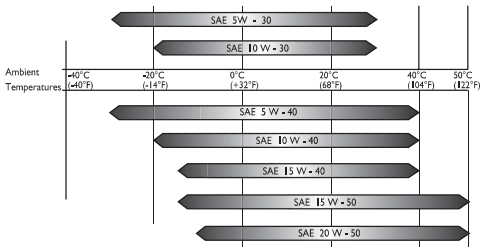

Fig.7.1. Recommended SAE Oil Viscosity Grades v.s. Ambient Temperatures

Generator Set, 50Hz&60Hz, 400V			Oil Capacity (L)	Coolant Capacity (L)
Model	Standby Power (kVA)	PSI Engine Model		
APG 25	25	2,4L	4,25	10,5
APG 33	33	4,3L (4X)	4,3	7,3
APG 40	40	4,3L (4X)	4,3	7,3
APG 50	50	4,3L (4X)	4,3	7,3
APG 80	80	5,7LT CAC	4,7	7,8
APG 105	105	5,7LT CAC	4,7	7,8
APG 135	135	8,8LT CAC	7,57	13,7
APG 165	165	8,8LT CAC	7,57	13,7
APG 180	180	8,8LT CAC	7,57	13,7
APG 270	270	13L	30	76
APG 300	300	14,6L	31	120
APG 440	440	21,9L	40	190
APG 500	500	21,9L HO	40	190
APG 680	680	32L	122	206
APG 825	825	40L	146	172
APG 1100	1100	53L	171	248
APG 33-6	33	2,4L	4,3	10,5
APG 60-6	60	4,3L (4X)	4,3	7,3
APG 100-6	100	5,7LT CAC	4,7	7,8
APG 120-6	120	5,7LT CAC	4,7	7,8
APG 165-6	165	8,8LT CAC	7,6	13,7
APG 200-6	200	8,8LT CAC	7,6	13,7
APG 210-6	210	8,8LT CAC	7,6	13,7
APG 320-6	320	13L	30	76
APG 380-6	380	14,6L	31	120
APG 450-6	450	14,6L HO	31	120
APG 525-6	525	21,9L	40	190
APG 640-6	640	21,9L	40	190
APG 825-6	825	32L	122	206
APG 990-6	990	40L	146	172
APG 1320-6	1320	53L	171	248

Generator Set, 50Hz&60Hz, 400V			Oil Capacity (L)	Coolant Capacity (L)
Model	Standby Power (kVA)	PSI Engine Model		
APG 28 LPG	27,5	2,4L	4,25	10,5
APG 33 LPG	33	4,3L (4X)	4,3	7,3
APG 40 LPG	40	4,3L (4X)	4,3	7,3
APG 50 LPG	50	4,3L (4X)	4,3	7,3
APG 75 LPG	75	5,7LNA	4,7	7,8
APG 95 LPG	95	5,7LT CAC	4,7	7,8
APG 110 LPG	110	8,8LT CAC	7,6	13,7
APG 155 LPG	155	8,8LT CAC	7,6	13,7
APG 180 LPG	180	10L	24	59
APG 300 LPG	300	21,9L	40	190
APG 440 LPG	440	32L	122	206
APG 540 LPG	540	40L	146	172
APG 825 LPG	825	53L	171	248
APG 33-6 LPG	33	2,4L	4,25	10,5
APG 60-6 LPG	60	4,3L (4X)	4,3	7,3
APG 90-6 LPG	90	5,7L NA	4,7	7,8
APG 110-6 LPG	110	5,7LT CAC	4,7	7,8
APG 132-6 LPG	132	8,8LT CAC	7,6	13,7
APG 180-6 LPG	180	8,8LT CAC	7,6	13,7
APG 185-6 LPG	185	10L	24	59
APG 375-6 LPG	375	21,9L	40	190
APG 525-6 LPG	525	32L	122	206
APG 645-6 LPG	645	40L	146	172
APG 970-6 LPG	970	53L	171	248

Table 7.1. Coolant lubricating oil capacities and lubricating oil specifications.

8. GENERAL PRECAUTIONS AND CONTROLS WHICH MUST BE DONE BEFORE STARTING UP THE GENERATING SET.

- Make a general visual inspection on the engine and alternator: Check if there is any breakage, crack, indentation, leakage or looseness. Never operate the generating set before removing any fault, if any.
- Take out foreign materials such as keys, tools, cleaning wool, papers etc. on the engine and the alternator.
- Never operate the generator in a humid atmosphere. Excessive moisture causes worsening of the generator insulation.
- Never operate the generator in excess of its limits as indicated in the technical specifications and avoid long no-load sequences.
- Check the lubrication oil level on the dipstick. Refill with an appropriate oil if it is low. Oil level normally must be close to the maximum level line.
- Look at the water level by opening the radiator tap. If it is inadequate add more water. Water level must be 30 mm lower than the water filling neck.
- Engine cooling water must include antifreeze according to the coolest weather conditions in the area. A mixture of 50% antifreeze and 50% water provides a good protection in all area.
- Inspect the radiator air outlet hood, open if clogged and clear away all obstructions in front of the air outlet.
- Check the air filter gauge. Clean or replace air filter, if necessary.
- Keep the inlet opening open.
- Make sure that the generating set can easily take air from the environment.
- Check the battery connection cables. Take care to tighten the loosened battery terminals with spanner and, cover with special substance and keep clean in order to avoid oxidation.
- Open the battery caps and check the liquid level in the cells for maintenance type battery. Add distilled water, if necessary, so as to be 1cm higher than the separation. Never fill the cells with tap water, acid water or acid.
- Check generator case grounding. When the generator is installed in a moist place or on a highly conductive material such as plate iron or steel work, be sure

to connect a grounding conductor to the grounding terminal provided near the output terminal block and bury the conductor deep in the ground securely (at a depth of 50 cm or more from the ground surface).

- Check bolts and nuts for looseness and tighten them
- Check electrical wiring for disconnection, short and/or terminal looseness.
- Check if the circuit breaker outlet switch is in OFF position.
- Make sure that the emergency stop button is not pressed.

9. GENERATING SET CONTROL SYSTEMS

To control and monitor the generating set, an electronic control system has been used.

P 732 control system is fitted the generating sets. Control panel provides a means of starting and stopping the generating set, monitoring its operation and output and automatically shutting down the set in the event of critical condition arising such as low oil pressure or high engine temperature.

9.1. Control Panel

Control, supervision and protection panels are mounted on the generator base frame.

9.1.1. Control System P 612

Control, supervision and protection panel is mounted on the generator set base frame.

Equipments:

- DSE, model 6020 Automatic Mains Failure module
- Static battery charger
- Emergency stop push button

DSE 6120 Module Features

- Automatic controls generating set, start and stop
- 3 phase generator and mains voltage monitoring
- Transfer between mains and generator power
- LCD display shows the status of the generator at all time
- 4- line, 64 x 132 graphic display with LED backlight
- PC and front panel configurable
- Easy push button control

STOP/RESET - MANUAL - AUTOMATIC - TEST - START

Display Scroll button Page button

Metering via LCD display

- Generator Volt (L-L, L-N)
- Generator Ampere (LI, L2, L3)
- Generator Frequency (Hz)
- Mains Volt (L-L /L-N)
- Mains Frequency
- Engine cooling temperature
- Engine oil pressure
- Engine speed
- Engine hours run
- Engine battery volt
- Event Log (5) events

Protections Warnings

- Generator High/Low Voltage
- Generator Over/ Under Frequency
- Over/Under Speed
- Engine low oil pressure
- High coolant temperature
- Battery High / Low voltage
- Charge alternator failure
- Fail to stop

Shutdowns

- Generator High/ Low Voltage
- Generator Over/ Under Frequency
- Over /Under Speed
- Engine low oil pressure
- High coolant temperature
- Emergency stop
- Over current
- Fail to start
- Oil pressure sensor open circuit
- Temperature sensor open circuit

LED display

- Mains Available
- Mains On Load
- Generator Available
- Generator On Load



Figure 9.1. DSE, model 6120 control module

9.1.2.. Control System P 732

P732 control system is fitted to 220kVA and above generator sets. It is designed to start and stop for all electronic or non–electronic diesel engines Generator Sets automatically , besides control module monitor the mains voltage , frequency and controls the generator set and transfer system. Control, monitor and protection panels are mounted on the generator base frame.

“DSE P732 AMF Control Module Operating Manual” is given along with the Gensets.

Equipments

- Control with DSE, model 7320 module.
- Static battery charger.
- Emergency stop push button.
- Relays, terminals etc.

Control Module DSE 7320 Features

- The module monitors mains supply and controls a standby generating set with automatic transfer switch
- Module indicates operational status and fault conditions by means of its LCD display.
- Microprocessor controlled.
- Front panel programming and also via PC software.
- 132 x 64 pixel LCD display makes information easy to read.
- Front panel programming and also via PC software.
- Soft touch membrane keypad and five key menu navigation.
- Remote communication via RS 232, RS 485 and Ethernet and SMS messaging.
- Event logging (50) showing date and time.
- Engine block heater control.

- Multiple date and time engine exercise mode and maintenance scheduler.

Controls;

Stop – Manual – Auto – Test – Start – Mute/Lamp test
 – Transfer to generator – Transfer to mains – Menu navigations buttons.

Instruments via LCD display

Engine

- Oil pressure (PSI & Bar)
- Temperature (°C & °F)
- Speed RPM
- Run time
- Battery volts
- Maintenance due

Generator

- Volts (L-L / L-N)
- Currents (L1, L2, L3)
- Frequency (Hz)
- kW
- Cos ϕ
- kVA, kVA_r,
- kWh, kVAh, kVA_rh
- Phase sequence

Mains

- Volts (L-L / L-N)
- Frequency (Hz)

Protections

Warning

- Charge failure
- Battery under voltage
- Fail to stop
- Low fuel level (opt.)
- kW over load
- Negative phase sequence
- Loss of speed signal

Pre-alarms

- Low oil pressure
- High engine temperature
- Low engine temperature
- Over/Under speed
- Under/over generator frequency

- Under/over generator voltage
- ECU warning

Shut Downs

- Fail to start
- Emergency stop
- Low oil pressure
- High engine temperature
- Low coolant level
- Over/Under speed
- Under/over generator frequency
- Under/over generator voltage
- Oil pressure sensor open
- Phase rotation

Electrical trip

- Earth fault (opt.)
- kW over load
- Generator over current
- Negative phase sequence

LED indication

- Mains available
- Mains on load
- Generator available
- Generator on load



Figure 9.2. DSE, model 7320 control module

10. GENERAL PRECAUTIONS AND CONTROLS WHICH MUST BE DONE AFTER STARTING UP THE GENERATING SET

- Whenever an abnormal conditions arises, e.g. excessive vibration, noise, odour, etc., switch the circuit breakers to OFF and stop the engine. Correct the faulty condition before restarting
- Never touch the power terminals during operation

of the machine.

- Check if the exhaust system has any leakage.
- Check for leakage of oil or cooling water.
- Monitor the generating set operation by means of the control module LCD display. Check the engine temperature and oil pressure. Oil pressure must reach the normal value 10 seconds after the generating set operation.
- Monitor the generating set outlet voltage and frequency by means of the control module LCD display. Check the voltage, if the voltage between phases is 400V, and between phase and neutral is 230V. Check that the frequency is 50 Hz on generating sets with electronic governors.
- If an engine block water heater is not available, run the generating set at no-load for 8 minutes and when the engine warm then apply on load (for manual models) Apply load to the generating set as follows:
 - Set the alternator outlet circuit breaker on the panel to ON position.
 - Set the load circuit breakers (or fuses) on the distribution panel to ON position one by one. This way, the generating set cannot be suddenly put under full load. Otherwise, the engine stalling or alternator winding insulation of formation or burning can occur.
 - Set the alternator outlet circuit breaker on the circuit to OFF position before stop the generating set.
 - Continue to run the unloaded engine for purpose of cooling period for 5 minutes and then stop.
 - Never operate the generating set before removing any fault, if any.
 - Running the generator at low load for long periods will reduce the lifetime of the engine.

11. GENERATING SET MAINTENANCE

A good maintenance program is the key to long generating set life. Maintenance and service should only be carried out by qualified technicians. The maintenance and service which are done must be recorded to the Maintenance Record Form. In general, the generating set should be kept clean. Do not permit liquids such as oil film to accumulate on any internal or external surfaces. Wipe down surfaces using an aqueous industrial cleaner.

11.1. Maintenance Schedule for Generator Sets

Using hour meter as a guide, perform all services at the hourly intervals indicated on following. At each maintenance interval, perform all previous maintenance operations in addition to the ones specified. Keep a record of hourly intervals and services performed.

Important: Recommended service intervals are for normal operating conditions. Service MORE OFTEN if engine is operated under adverse conditions. Neglecting maintenance can result in failures or permanent damage to the engine.

Use correct fuels, Lubricants and coolant.

Run the engine regularly, e.g. once a week, until it is warmed up.

A. Daily

Check

- Visually inspect engine, generator, transfer switch and control panel.
- For, Oil, Water and Fuel leaks.
- For, Coolant level, Oil level
- Battery charge level
- Operation of coolant heater
- Inspect the engine fan blades
- Inspect the drive belt

B. Weekly

Repeat Daily

Check

Fuel System

- Fuel lines and connections

Cooling System

- Adequate fresh air to engine
- Hose and connections
- Battery charging alternator belts
- Inspect the engine fan blades
- Inspect the fan belt

Lubricating System

- Oil level

- Tighten connections

Exhaust System

- Exhaust leaks
- Tighten connections

Generator

- Vent screens
- Tighten covers
- Output voltage and frequency

Transfer Switch

- Operation under load
- No unusual sounds
- Terminals and connections normal colour
- Doors closed securely

• The following maintenance details should be executed thoroughly at regular intervals.

Certified Stationary Engine Maintenance Requirements

Perform the following maintenance on the engine at the hours indicated and at equivalent hour intervals thereafter:

	Interval Hours									
	Daily	1000	1500	2000	2500	3000	3500	4000	4500	5000
General Maintenance Section										
Visual check for fluid leaks	X									
Check engine oil level	X									
Check coolant level	X									
Change engine oil and filter	Every 150 hours or 120 days of operation									
Check LPG system for leaks	Prior to any service or maintenance activity									
Inspect accessory drive belts for cracks, breaks, splits or glazing		X		X		X		X		X
Inspect electrical system wiring for cuts, abrasions or corrosion				X				X		
Replace crankcase breather element - 8.1L/8.8L Engine	Every 150 hours or 120 days of operation									
Inspect all vacuum lines and fittings for cracks, breaks or hardening				X				X		
Engine Coolant Section										
Clean debris from radiator core	Every 100 hours or 60 days of operation									
Change coolant ¹										X
Inspect coolant hoses for cracks, swelling or deterioration		X		X		X		X		X
Engine Ignition System										
Replace spark plugs			X			X				
Clean secondary ignition coil tower		X		X		X		X		X
Check spark plug wires for cuts abrasions or hardening		X								
Replace distributor cap and rotor				X				X		
Replace spark plug wires				X				X		
Fuel System Maintenance										
Inspect air cleaner	Every 200 hours, or every 100 hours in dusty environment									
Replace filter element	Annually, or as required in dusty environments									
Replace fuel filter		X		X		X		X		X
Inspect Shut-off Valve for leaks and closing				X				X		
Leak check fuel lines				X				X		
Check air induction for leaks		X		X		X		X		X
Check manifold for vacuum leaks		X		X		X		X		X
Drain Vaporizer oil build up	Every 2500 hrs or As Required									
Engine Exhaust System										
Inspect exhaust manifold for leaks				X				X		
Inspect exhaust piping for leaks				X				X		
Check HEGO sensor(s) connector and wires for burns, cuts or damage				X				X		
Inspect catalyst for mechanical damage				X				X		

SPECIAL NOTES SECTION

Note 1 = PSI requires the use of coolant meeting GM specification GM6277M. When used, this coolant change interval is 5,000 hours or 5 years (whichever occurs first). Changing of coolant types (typically indicated by color) and mixing of coolants is not allowed as this can result in a loss of coolant protection during the engine life. Consult the OEM for the correct replacement interval if you use coolant other than GM6277M.

Table 12. Engine Maintenance Guidelines for 2.4L, 3.0L, 4.3L, PSI 4.3L (4X), 5.0L/5.7L Turbo, 8.8L Turbo

Maintenance Intervals – Emergency						
Event Number	Maintenance Event	Weekly	Interval			Every Two Years
			The first 50 hours	6 months	250 hrs or 1 year	
1	Check Engine Oil Level	X	X			
2	Check Engine Coolant Level	X	X			
3	Check Oil Pressure	X	X			
4	Check Overall Operating Condition (hose/clamp/pipe/belt/harness/connector)	X	X			
5	Change Oil and Oil Filter * (Sample)#				X	
6	Check/Adjust Valve Lash				X	
7	Spark Plugs (Check/Adjust/Replace)				X	
8	Check Air Filter * (Inspect/Replace)				X	
9	Replace Breather Filter (10L only)				X	
10	Belts**, Pipes, Clamps and Hoses (Inspect/Replace)		X	X		
11	Check Ignition System (Plug Wires/Coils)			X		
12	Check Coolant Condition * (Sample)				X	
13	Inspect Water Pump				X	
14	Test Batteries & Alternator				X	
15	Inspect Turbocharger (10L Turbo only)				X	
16	Replace Coolant					X

Maintenance Intervals– Non-emergency						
Event Number	Maintenance Event	Weekly	Interval			Every Two Years
			The first 50 hours	6 months	250 hrs or 1 year	
1	Check Engine Oil Level	X	X			
2	Check Engine Coolant Level	X	X			
3	Check Oil Pressure	X	X			
4	Check Overall Operating Condition (hose/clamp/pipe/belt/harness/connector)	X	X			
5	Change Oil and Oil Filter * (Sample)#			X		
6	Check/Adjust Valve Lash			X		
7	Replace Breather Filter (10L only)				X	
8	Check Air Filter * (Inspect/Replace)			X		
9	Replace Breather Filter (10L only)				X	
10	Belts**, Pipes, Clamps and Hoses (Inspect/Replace)		X	X		
11	Check Ignition System (Plug Wires/Coils)			X		
12	Check Coolant Condition * (Sample)					X
13	Inspect Water Pump					X
14	Test Batteries & Alternator					X
15	Inspect Turbocharger (10L Turbo only)					X
16	Replace Coolant					Every 2 Years

Table 13. Engine Maintenance Guidelines for 10L and 13L.

PSI Energy 53L Standby Engine Maintenance Guidelines

	Initial 50 Hour Service*	Annual Service	Every Two Years
Check for fluid leaks	X	X	
Check engine oil level	X	X	
Check coolant level	X	X	
Inspect drive belts for tension, cracks, splits, or glazing	X	X	
Inspect air cleaner filter element, replace as needed	X	X	
Inspect electrical system and harnesses for cluts, abrasions or wear	X	X	
Inspect all vacuum lines and fittings for cracks, breaks or hardening	X	X	
Inspect coolant hoses for cracks, swelling or deterioration	X	X	
Inspect Fuel Shut-off Valves for leaks and proper operation	X	X	
Inspect gas piping and hoses for leaks or damage	X	X	
Check air induction piping for leaks	X	X	
Inspect automatic belt tensioners, replace if necessary	X	X	
Check intake manifold for vacuum leaks	X	X	
Inspect exhaust manifold for leaks	X	X	
Inspect exhaust piping for leaks	X	X	
Inspect O ₂ sensors and harness for damage/performance	X	X	
Inspect catalyst for mechanical damage and performance	X	X	
Sample engine oil as needed	X	X	
Change engine oil and filter**	X	X	
Adjust intake and exhaust valve clearance	X	X	
Clean debris from radiator core	X	X	
Tighten all hose clamps on CAC piping boots	X	X	
Drain LPL vaporizer oil build up (if LP fuel system is installed)	X	X	
Inspect ignition coils and harness		X	
Replace spark plugs			X
Drain, flush, and replace engine coolant**			X
Replace fan and water pump belts			X
Replace ignition coils			X
Replace throttle body			X

* First 50 hours only

**Oil and coolant change intervals can be extended only with a regularly scheduled sampling program

Table 14. Engine Maintenance Guidelines for 40L and 53L

Engine maintenance

Refer to the engine's operator manual for full maintenance, including instructions for changing the oil and cooling water and replacing the oil and air filters.

12. ENGINE TROUBLESHOOTING

Condition	Causes	Remedies
1) Starting difficult (1) Compression pressure	<ul style="list-style-type: none"> • Valve's poor shut, stem • Valve spring damage • Cylinder head gasket's leak • Wear of piston, piston ring or liner 	Repair or replace Replace valve spring Replace gasket Adjust
2) Idle operation abnormal	<ul style="list-style-type: none"> • Ignition timing incorrect • Valve clearance incorrect • Valve tightness poor • Cylinder head gasket's leak • Wear, stick, damage of piston ring • Ignition timing incorrect • Damage of spark plug & ignition • Air suction amount insufficient • Turbocharger poor 	Adjust Adjust Repair Replace gasket Replace piston ring Adjust Adjust or replace Clean or replace air cleaner Repair or replace
3) Engine output insufficient (1) Continuous output insufficient	<ul style="list-style-type: none"> • Compression pressure insufficient • Ignition timing incorrect • Damage of spark plug & ignition coil • Air intake amount insufficient 	Disassemble engine Adjust Repair or replace Clean or replace air cleaner
(2) Output insufficient when in acceleration	<ul style="list-style-type: none"> • Engine oil insufficient or poor • Cooling water insufficient • Fan belt loosened, worn, damaged • Cooling water pump's function lowered • Thermostat operation poor • Valve clearance incorrect • Exhaust system's resistance increased 	Replenish or replace Replenish or replace Adjust or replace Repair or replace Replace Adjust Clean or replace
4) Overheating	<ul style="list-style-type: none"> • Engine oil insufficient or poor • Cooling water insufficient • Fan belt loosened, worn, damaged • Cooling water pump's function lowered • Thermostat operation poor • Valve clearance incorrect • Exhaust system's resistance increased 	Replenish or replace Replenish or replace Adjust or replace Repair or replace Replace Adjust Clean or replace

13. ALTERNATOR DESCRIPTION

13.1. General

The alternator fitted on the generating set is of the brushless self-excitation type which eliminates the maintenance associated with slip rings and brushes. The control system, consist of an automatic voltage regulator, protective circuits.

13.2. Construction and Components

The stator core is produced from insulated low loss electrical grade sheet steel laminations. These are built and welded under a fixed pressure to give an extremely rigid core to withstand vibration and load impulses. The complete wound stator is, after impregnation,

pressed into the frame and pinned into position.

The rotor assembly, which comprises the alternator rotating field systems, the exciter rotating diode system and the cooling fan. The complete rotor assembly is dynamically balanced to ensure vibration-free running. At the drive end of the rotor assembly a cast-aluminum centrifugal fan draws cooling air through screened covers at the non drive end and discharges it through similar side mounted covers at the drive end.

13.3. Operation

The electrical power produced by the generating set is derived from a closed loop system consisting principally of the exciter rotor the man revolving field and

the automatic voltage regulator (see Figure 13.1) The process begins when the engine starts to rotate the internal components of the alternator. The residual magnetism in the main rotor produces a small alternating voltage (AQ in the main stator. The automatic voltage regulator rectifies this voltage (converts it to DC) and applies it to the exciter stator:

This DC current to the exciter stator creates a magnetic field which in turn, induces an AC voltage in the exciter rotor. This AC voltage is converted back to DC by the rotating diodes.

When this DC voltage appears at the main rotor, a stronger magnetic field than the original residual field is created which induces a higher voltage in the main stator. This higher voltage circulates through the system including an even higher DC voltage back at the main rotor. This cycle continues to build up the voltage unit. It approaches the proper output level of the generating set. At this point the automatic voltage regulator begins to limit the voltage being passed to the exciter stator which, in turn, limits the overall power output of the alternator.

This build-up process takes place in less than one second.

13.4. Automatic Voltage Regulator

The Automatic Voltage Regulator (AVR) maintains a no load to full load steady state voltage to tight tolerances. The AVR has a volt/hertz characteristic which proportionally reduces the regulated voltage at reduced.

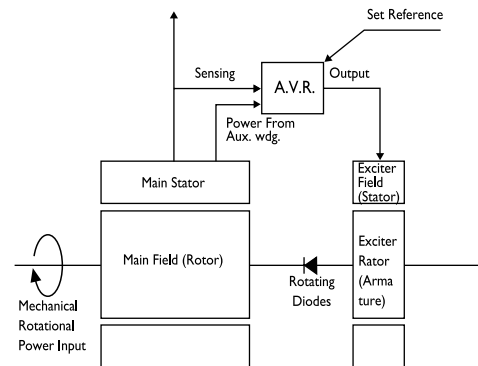

Figure, 13.1. Meccalte alternator; operating principles block schematic diagram

14. VENTS AND DUCTS

1. For indoor installations, locate vents so incoming air passes through the immediate area of the installation before exhausting. Install the air outlet higher than the air inlet to allow for convection air movement.

2. Size the vents and ducts so they are large enough to allow the required flow rate of air.

3. Wind will restrict free airflow if it blows directly into the air outlet vent. Locate the outlet vent so the effects of wind are eliminated, or if the outlet vent cannot be located as mentioned, install a wind barrier. See Figure 8

- No.1 : Prevailing Wind Away from Air Outlet Vent
- No.2 : Prevailing Wind Towards Air Outlet Vent, Wind Barrier Installed

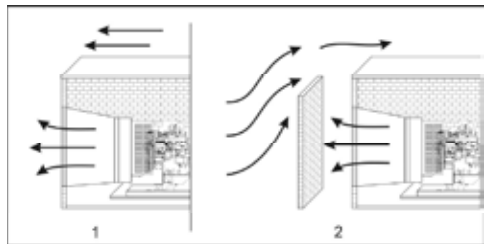

Fig. 12.1. Wind Barrier

NOTICE

The "free area" of ducts must be as large as the exposed area of the radiator. Refer to the generator set Specification Sheet for the airflow requirements and allowed airflow restriction.

15. MECCALTE ALTERNATOR TROUBLESHOOTING

Symptom	Corrective Action	Possible Cause
Alternator does not excite	Blown fuse Insufficient residual voltage No residual voltage	Replace fuse Increase speed by 15 %. For an instant apply on the (+) and (-) terminals of the electronic regulator a 12V battery with 30 ohm resistor in series respecting the polarities.
After being excited alternator does no excite	Connections are interrupted	Check connection cables as per attached drawings.
Low voltage at no load	Voltage potentiometer out of setting Invention of protection. Winding failure	Reset voltage Check engine speed Check windings
High voltage at no load	Voltage potentiometer out of setting Failed regulator	Reset voltage potentiometer Substitute regulator
Lower than rated voltage at load	Voltage potentiometer out of setting Intervention by protection Failed regulator Rotating bridge failure	Reset voltage potentiometer Current to high, power factor lower than 0,8; speed lower than 4% of rated speed Substitute regulator Check diodes, disconnect cables.
Higher than rated voltage at load	Voltage potentiometer out of setting Failed regulator	Reset voltage potentiometer Substitute regulator
Unstable voltage	Speed variation in engine Regulator out of setting	Check regularity of rotation Regulate stability of regulator by acting on stability potentiometer.

16. STORAGE OF THE GENERATOR

16.1. Storage

- Store the generator in a dry, frost -free room which is well ventilated.
- Run the engine regularly, e.g. once a week, until it is warmed up. If this is impossible, extra precautions must be taken:
- Consult the engine's operator manual.
- Remove the battery. Store it in a dry, frost-free room. Keep the battery clean and its terminals lightly covered with petroleum jelly. Recharge the battery regularly.

- Clean the generator and protect all electrical components against moisture.

- Stick sheets of VCI paper with adhesive tape on the bodywork to close off all openings.
- Wrap the generator; except the bottom, with a plastic bag. If possible use space heaters to keep the windings dry.

16.2. Preparing for Operation After Storage

Before operating the generator again, remove the wrapping, VCI paper and check the generator thoro-

- ughly (go through the checklist "8. Before starting").
- Consult the engine's operator manual.
 - Check that the insulation resistance of the generator exceeds 5 MΩ
 - Reinstall and connect the battery, if necessary after being recharged.
 - Submit the generator to a test run.

GENERAL PRECAUTIONS ABOUT WARRANTY

DEAR AKSA GENERATING SET OPERATOR, PLEASE TAKE CARE TO THE FOLLOWING ORDER TO PREVENT THE GENERATING SET WARRANTY TO BECOME INVALID BEFORE THE TERMINATION OF THE WARRANTY PERIOD AND TO ENSURE TROUBLE-FREE OPERATION OF THE GENERATING SET WITH A LONG LIFE!

- MAINTENANCE AND REPAIR WORKS WILL NOT BE COVERED BY THE WARRANTY CERTIFICATE, INVOICE OR DELIVERY CERTIFICATE OF THE GENERATING SET IS SUBMITTED.
- THE WARRANTY OF THE GENERATING SET WILL BECOME INVALID IN CASE OF ANY INTERVENTION OF ANY PERSON OTHER THAN AUTHORIZED AKSA SERVICES OR BY PRIOR WRITTEN APPROVAL FROM AKSA POWER GENERATION ON THE GENERATING SET FOR ANY REASON.
- CONTROL AND MAINTENANCE WORKS INDICATED IN THE PERIODICAL MAINTENANCE SCHEDULE AND THE OPERATING MANUAL MUST BE CARRIED OUT COMPLETELY AND TIMELY THE FAILURES DUE TO INCOMPLETE OR UNTIMELY MAINTENANCE ARE NOT COVERED BY THE WARRANTY.
- GENERATING SET SHOULD BE MOUNTED AS INDICATED IN THE OPERATING MANUAL OTHERWISE, THE PROBLEMS WHICH ARE LIKELY TO OCCUR WILL NOT BE COVERED BY THE WARRANTY.
- THE OIL TYPE INDICATED IN THE OPERATING MANUAL SHOULD BE USED IN THE ENGINE OTHERWISE, THE FAILURES WHICH ARE LIKELY TO OCCUR WILL NOT BE COVERED BY THE WARRANTY.
- BATTERIES WILL NOT BE COVERED BY THE WARRANTY IF THEY ARE SUBJECTED TO BREA-

KAGE, EXCESSIVE ACID FILL OR HARDNING BY LEAVING UNCHARGED.

- GENERATING SETS, NEVER START OR STOP THE ENGINE WHEN THE GENERATING SET IS UNDER LOAD. ENGINE SHOULD BE STARTED AND STOPPED AFTER LOAD IS DISCONNECTED AND THE GENERATING SET IS AT IDLE CONDITION. OTHERWISE, THE VALVES CAN BE SEIZED, THE VOLTAGE REGULATOR, TRANSFORMER AND DIODES CAN BE BROKEN DOWN. THESE CONDITIONS ARE NOT COVERED WARRANTY.
- OUR COMPANY DOES NOT TAKE THE RESPONSIBILITY OF THE DAMAGES ON THE MAINS SUPPLY CONTACTOR OF THE AUTOMATIC GENERATING SETS DUE TO OVERCURRENT, LOW OR HIGH VOLTAGE.
- NEVER REMOVE THE BATTERY TERMINALS WHILE THE GENERATING SET IS IN USE. EVEN A MOMENT OF DISCONNECTION CAN CAUSE A DAMAGE ON THE ELECTRONIC CLOSING RELAY OF THE CHARGE ALTERNATOR THESE CONDITION ARE NOT COVERED BY THE WARRANTY.
- FAILURES DUE TO OVERLOAD AND UNBALANCED LOAD IN EXCESS OF THE GENERATING SET POWER (SUCH AS ALTERNATOR AND CONTACTOR FAILURES) ARE NOT COVERED BY THE WARRANTY.
- WHEN THE MANUAL GENERATING SET IS STARTED UP, IT SHOULD BE WARMED BY OPERATING AT IDLE FOR 5 MINUTES .WHEN STOPPING THE DIESEL ENGINE, IT SHOULD BE UNLOADED AND THEN CONTINUED TO BE OPERATED FOR COOLING FOR 10 MINUTES BEFORE STOPPING. OTHERWISE PROBLEMS WHICH ARE LIKELY TO OCCUR WILL NOT BE COVERED BY THE WARRANTY
- WARRANTY PERIOD IS 1 YEAR BEGINNING FROM THE PURCHASE DATE.

Authorized Service Dealer may perform warranty repairs. Most warranty repairs are handled routinely, but sometimes requests for warranty service may not be appropriate. For example, warranty service would not apply if equipment damage occurred because of misuse, lack of routine maintenance, shipping, handling, warehousing or improper installation. Similarly, the

warranty is void if the manufacturing date or the serial number on the equipment has been removed or the equipment has been altered or modified. During the warranty period, the Authorized Service Dealer, at its option, will repair or replace any part that, upon examination, is found to be defective under normal use and service. This warranty will not cover the following repairs and equipment:

- **Normal Wear:** Power Equipment and engines, like all mechanical devices, need periodic parts and service to perform well. This warranty does not cover repair when normal use has exhausted the life of a part or the equipment.
- **Installation and Maintenance:** This warranty does not apply to equipment or parts that have been subjected to improper or unauthorized installation or alteration and modification, misuse, negligence, accident, overloading, over speeding, improper maintenance, repair or storage so as, in our judgment, to adversely affect its performance and reliability. This warranty also does not cover normal maintenance such as adjustments, fuel system cleaning and obstruction (due to chemical, dirt, carbon, lime, and so forth).
- **Other Exclusions:** This warranty excludes wear items such as, o-rings, filters, fuses, or spark plugs, etc., or damage or malfunctions resulting from accidents, abuse, modifications, alterations, or improper servicing or freezing or chemical deterioration. Accessory parts are excluded from the product warranty. This warranty excludes failures due to acts of God and other force majeure events beyond the manufacturer's control.

AKSA JENERATÖR YETKİLİ SERVİS NOKTALARI

İSTANBUL AVRUPA YAKASI

AVCILAR

MUSTAFA KEMAL PAŞA MAH. YILDIRIM BEYAZIT CAD. DEMET SOK. NO:132 AVCILAR/İSTANBUL
444 4 630 • aksa@aksa.com.tr

KAĞITHANE

ÇAĞLAYAN MAH. KAĞITHANE CAD. NO:93/A KAĞITHANE
444 4 630 • aksa@aksa.com.tr

KARAKÖY

NECATİBEY CAD NO.74 KARAKÖY / İSTANBUL
444 4 630 • aksa@aksa.com.tr
DOLAPDERE SAN. SİT. 13.ADA NO:9 İKİTELLİ
444 4 630 • aksa@aksa.com.tr

İSTANBUL ANADOLU YAKASI

AYDINEVLER ÂŞIK VEYSEL SOK. AK PLAZA NO:24 KÜÇÜKYALI/MALTEPE
444 4 630 • aksa@aksa.com.tr

İSTANBUL DIŞI SERVİS NOKTALARI

ANKARA

ÇETİNEMEÇ BLV.1065.CAD 1309 SOK NO:7 A/BLOK ÇANKAYA
444 4 630 • aksa@aksa.com.tr

ADANA

TURHAN CEMAL BERİKER BUL. ADANA İŞ MERKEZİ
A BLOK NO:24/27 YEŞİLOBA SEYHAN
444 4 630 • aksa@aksa.com.tr

ANTALYA

ASPENOS BULVARI YEŞİLOVA MAH. 198/2-3 MURATPAŞA
444 4 630 • aksa@aksa.com.tr

BURSA

NİLÜFER TİC. MRK. ALAADDİNBEY MAH. 70 SK.
NO:12/B NİLÜFER
444 4 630 • aksa@aksa.com.tr

DENİZLİ

ADNAN MENDERES BULVARI ZAFER MAH.
İZMİR ASFALTI ÜZERİ NO:70
444 4 630 • aksa@aksa.com.tr

DİYARBAKIR

MEZOPOTAMYA MAH. MAHABAD BULVARI EYYÜP ANDAN
CITY NO 79/A KAYAPINAR
444 4 630 • aksa@aksa.com.tr

GAZİANTEP

MÜCAHİTLER MAH.12 NOLU CD.GÜLEVLER SİT. A BLOK ALTI
NO:20 ŞEHİTKAMİL
444 4 630 • aksa@aksa.com.tr

İZMİR

FATİH MAH. 1203 SK. NO:29 A / MERKEZ
444 4 630 • aksa@aksa.com.tr

KAYSERİ

ORGANİZE SANAYİ BÖLGESİ CAD:21 NO:20 MELİKGAZI
444 4 630 • aksa@aksa.com.tr

MUĞLA - BODRUM

CUMHURİYET CAD. KIVILCIM İŞ MERKEZİ
A/BLOK NO : I ORTAKENT
444 4 630 • aksa@aksa.com.tr

MUĞLA - MARMARİS

SARIANA MAH.23 SOKAK NO:2/1 MARMARİS
444 4 630 • aksa@aksa.com.tr

SAMSUN

TOYBELEN MAH. 1301. SOK.
No: 177 İLKADIM
444 4 630 • aksa@aksa.com.tr

ŞANLIURFA

MEHMETÇİK MAH. 10004 SK. ATAŞEHİR İŞ MERKEZİ
T1 BLOK NO:4 KARAKÖPRÜ
444 4 630 • aksa@aksa.com.tr

TEKİRDAĞ

ALİPAŞA MAH. ÇETİN EMEÇ BULVARI
NO: 60-66 / C-D ÇORLU
444 4 630 • aksa@aksa.com.tr

TRABZON

KARŞIYAKA MAH. YAVUZ SELİM BULVARI
MANOLYA SİTESİ 467/A
444 4 630 • aksa@aksa.com.tr

BRANCH OFFICES & WAREHOUSES



ALGERIA

Eurl Aksa Générateurs Algérie
Zone Industrielle Oued Smar Lot
N° 55 Harrach / Alger / Algerie
T : + 213 23 92 06 56-57-58
contact@aksa-dz.com



CHINA

Aksa Power Generation Co. Ltd.
No.19 Tongjiang North Road,
New District, Changzhou / China
T: + 86 (0) 519 851 50 205
e-mail: aksa@aksapowergen.com



GHANA

Aksa Power Generation (Gana)
11 Trinity Avenue, East Legon,
Greater Accra / Ghana
T : +233 206 99 88 00
e-mail: info@aksaghana.com



IRAQ

Aksa Power Generation (Iraq)
English Village House
No:353 Arbil / Iraq
T : + 964 (0) 770 761 12 20
e-mail: export@aksa.com.tr



INDONESIA

Aksa Power Generation (Endonezya)
Menara Palma Lantai 3 unit 3-03
Jalan HR Rasuna Said Blok X2 Kav.6
Kelurahan Kuningan Timur
Kecamatan Setiabudi Jakarta Selatan,
Jakarta, Indonesia
T: +21 5795 7590



KAZAKHISTAN

Aksa Kazakhstan
89a Suynbay ave.
Almaty city / KAZAKHSTAN
T: +7 (727) 338 48 47
e-mail: info@aksakz.kz



KENYA

Sunflag Industrial Park No:3 Mombasa Rd.
P.O. Box 196-00519 Nairobi / Kenya
T: +254 792 423 359
e-mail: info@aksakenya.com



NETHERLANDS

Aksa Europe
Merwedestraat 48P 3313CS,
Dordrecht/Netherlands
T: +31 (0)6 4170 1172
e-mail: sales@aksaeurope.com



RUSSIA

Aksa Russia
119530, Ochakovskoye Shosse 34,
4th floor, VII/10 Moscow / RUSSIA
T : +7 495 710 88 62
e-mail : info@aksarusia.ru



SINGAPORE

Aksa Far East(Pte.) Ltd.
94 Tuas Avenue 11
639103 Singapore
T : + 65 6863 2832
e-mail: aksafe@aksafareast.com.sg



SUDAN

Aksa Power Generation (Sudan)
Sudan, Khartoum State, Khartoum, Ryad,
Omak Street block 8, Building Number 4,
East Side / Sudan
e-mail : murat@aksasudan.com



SOUTH AFRICA

Aksa Power Generation [South Africa]
109 Roan Crescent, Corporate Park North,
1685, Midrand, Johannesburg
South Africa
T: +27 60 774 64 88
e-mail : aksa@aksa.com.tr



U.A.E.

Power Generation FZE
Po Box:18167 Jebel Ali Free Zone
Warehouse No.RA08 / LC07 Dubai / UAE
T : + 971 4 880 91 40
e-mail: sales@aksa.ae



UNITED KINGDOM

Aksa International (UK) Ltd
Unit 6, Pine Court Walker Road, Bardon Hill
Coalville Leicestershire, LE67 1SZ U.Kingdom
T : + 44 (0) 1530 837 472
e-mail: sales@aksa-uk.com



U.S.A.

Aksa USA
371 Exchange Street
West Monroe, LA 71292
T: +1 318 855 83 77
e-mail: sales@aksausa.com



UZBEKISTAN

Aksa Uzbekistan
18/1, Oybek Street
Tashkent / Uzbekistan
T: + 998 (78) 150 27 47
e-mail: info@aksa.uz



VIETNAM

Aksa Vietnam
28 Ter B Mac Dinh Chi Street Dako
Ward District 1, HCM City - Vietnam
T : + 84 8 391 47 014
e-mail: vietnam@aksapowergen.com

AKSA JENERATÖR SANAYİİ A.Ş.



**DECLARATION OF CONFORMITY
AB - UYGUNLUK BEYANI**

Üretici / Manufacturer : **AKSA Jeneratör San. A.Ş.**

Adres / Address : **Rüzgarlı Bahçe Mah. Özalp Çıkmazı No:10
Kavacık / Beykoz / İstanbul / Türkiye**

Ürün Kodu Product Code(s) :

Ürün Açıklaması : **Otomatik Tip Kabinli Jeneratör**

Production Description : **Automatic Generator with Canopy**

Deklerasyon / Declaration

Aksa Jeneratör San. A.Ş. olarak, yukarıda bilgileri verilmiş olan ürünün aşağıdaki Avrupa Birliği direktiflerine, standartlara ve bunların gerektirdiği şartlara uygun olduğunu beyan ederiz.

On behalf of AKSA Jeneratör San. A.Ş. ,We declare that above information in relation on the supply/manufacture of this in product is in conformity with the below stated standards, EC directives and provisions of them.

Avrupa Birliği Direktifleri / EC Directives

2006/42/AT : Makine Emniyeti Yönetmeliği

2006/42/EC : Machinery Safety Directive

2014/30/AB : Elektromanyetik Uyumluluk Yönetmeliği

2014/30/EU : Electromagnetic Compatibility Directive

2014/35/AB : Alçak Gerilim Yönetmeliği

2014/35/EU : Low Voltage Directive

Standartlar / Standards

- **TS EN ISO 12100:2010** : Makinelerde Güvenlik - Tasarım İçin Genel Prensipler –Risk Değerlendirilmesi ve risk azaltılması
EN ISO 12100:2010 : Safety of machinery — General principles for design-Risk assessment and risk reduction
- **TS EN ISO 3744:2010** : Akustik - Gürültü Kaynaklarının Ses Gücü Seviyelerinin Ses Basıncı Kullanarak Tayini - Bir Yansıtma Düzlemi Boyunca, Esas Olarak Serbest Bir Alan İçinde Uygulanan Mühendislik Metodu
EN ISO 3744:2010 : Acoustics. Determination of sound power levels of noise sources using sound pressure. Engineering method in an essentially free field over a reflecting plane
- **TS EN 60204-1** : Makinelerde güvenlik - Makinelerin elektrik donanımı - Bölüm 1: Genel kurallar
EN 60204-1:2018 : Safety of machinery - Electrical equipment of machines Part 1: General requirements
- **TS EN ISO 8528-13:2016** : Gidip gelme hareketli içten yanmalı motor tahrikli alternatif akım jeneratör grupları - Bölüm 13: Emniyet
EN ISO 8528-13:2016 : Reciprocating internal combustion engine driven alternating current generating sets - Part 13: Safety
- **TS EN 61000-4-2:2009** : Elektromanyetik Uyumluluk (EMU)-Bölüm 4-2: Deney Ölçme Teknikleri-Elektrostatik Boşalma Bağışıklık Deneyi
BS EN 61000-4-2:2009 : Electromagnetic compatibility (EMC). Testing and Measurement Techniques.Electrostatic Discharge Immunity Test
- **TS EN 61000-4-6:** : Elektromanyetik Uyumluluk (EMU)-Bölüm 4-6: Deney Ölçme Teknikleri-Radyo Frekans Alanlarının Neden Olduğu Temaslı Rahatsızlıklara Karşı Bağışıklık
BS EN 61000-4-6: 2014 : Electromagnetic compatibility (EMC). Testing and Measurement Techniques.Immunity to Conducted Disturbance Induced by Radio-Frequency Fields
- **TS EN 614-1+A1** : Makinelerde güvenlik – Ergonomik tasarım prensipleri-Bölüm 1:Terminoloji ve genel prensipler
EN 614-1:2006+A1(2009): Safety of machinery – Ergonomic design principles – Part 1 : Terminology and general principles

Yayım / Issued by : **AKSA Jeneratör San. A.Ş.**

Yer - Tarih / Place - Date : **İstanbul -**

Firma Adına Yetkili : **İbrahim YILDIRIM**

Name of Authorized Representative

Unvan / Title : **Global Üretim Direktörü / Global Production Director**

İmza / Signature

AKSA JENERATÖR SANAYİİ A.Ş.



**DECLARATION OF CONFORMITY
AB - UYGUNLUK BEYANI**

Üretici / Manufacturer : **AKSA Jeneratör San. A.Ş.**

Adres / Address : **Rüzgarlı Bahçe Mah. Özalp Çıkmazı No:10
Kavacık / Beykoz / İstanbul / Türkiye**

Ürün Kodu Product Code(s) :

Ürün Açıklaması : **Otomatik Tip Açık Jeneratör**

Production Description : **Automatic Generator with Out Canopy**

Deklerasyon / Declaration

Aksa Jeneratör San. A.Ş. olarak, yukarıda bilgileri verilmiş olan ürünün aşağıdaki Avrupa Birliği direktiflerine, standartlara ve bunların gerektirdiği şartlara uygun olduğunu beyan ederiz.

On behalf of AKSA Jeneratör San. A.Ş. ,We declare that above information in relation on the supply/manufacture of this in product is in conformity with the below stated standards, EC directives and provisions of them.

Avrupa Birliği Direktifleri / EC Directives

2006/42/AT : **Makine Emniyeti Yönetmeliği**

2006/42/EC : **Machinery Safety Directive**

2014/30/AB : **Elektromanyetik Uyumluluk Yönetmeliği**

2014/30/EU : **Electromagnetic Compatibility Directive**

2014/35/AB : **Alçak Gerilim Yönetmeliği**

2014/35/EU : **Low Voltage Directive**

Standartlar / Standards

- **TS EN ISO 12100:2010** : Makinelerde Güvenlik - Tasarım İçin Genel Prensipler –Risk Değerlendirilmesi ve risk azaltılması
EN ISO 12100:2010 : *Safety of machinery — General principles for design-Risk assessment and risk reduction*
- **TS EN ISO 3744:2010** : Akustik - Gürültü Kaynaklarının Ses Gücü Seviyelerinin Ses Basıncı Kullanılarak Tayini - Bir Yansıtma Düzlemi Boyunca, Esas Olarak Serbest Bir Alan İçinde Uygulanan Mühendislik Metodu
EN ISO 3744:2010 : *Acoustics. Determination of sound power levels of noise sources using sound pressure. Engineering method in an essentially free field over a reflecting plane*
- **TS EN 60204-1** : Makinelerde güvenlik - Makinelerin elektrik donanımı - Bölüm 1: Genel kurallar
EN 60204-1:2018 : *Safety of machinery - Electrical equipment of machines Part 1: General requirements*
- **TS EN ISO 8528-13:2016** : Gidip gelme hareketli içten yanmalı motor tahrikli alternatif akım jeneratör grupları - Bölüm 13: Emniyet
EN ISO 8528-13:2016 : *Reciprocating internal combustion engine driven alternating current generating sets - Part 13: Safety*
- **TS EN 61000-4-2:2009** : Elektromanyetik Uyumluluk (EMU)-Bölüm 4-2: Deney Ölçme Teknikleri-Elektrostatik Boşalma Bağışıklık Deneyi
BS EN 61000-4-2:2009 : *Electromagnetic compatibility (EMC). Testing and Measurement Techniques. Electrostatic Discharge Immunity Test*
- **TS EN 61000-4-6:** : Elektromanyetik Uyumluluk (EMU)-Bölüm 4-6: Deney Ölçme Teknikleri-Radyo Frekans Alanlarının Neden Olduğu Temaslı Rahatsızlıklara Karşı Bağışıklık
BS EN 61000-4-6:2014 : *Electromagnetic compatibility (EMC). Testing and Measurement Techniques. Immunity to Conducted Disturbance Induced by Radio-Frequency Fields*
- **TS EN 614-1+A1** : Makinelerde güvenlik – Ergonomik tasarım prensipleri-Bölüm 1: Terminoloji ve genel prensipler
EN 614-1:2006+A1(2009) : *Safety of machinery – Ergonomic design principles – Part 1 : Terminology and general principles*

Yayım / Issued by : **AKSA Jeneratör San. A.Ş.**

Yer - Tarih / Place - Date : **İstanbul -**

Firma Adına Yetkili : **İbrahim YILDIRIM**

Name of Authorized Representative

Unvan / Title : **Global Üretim Direktörü / Global Production Director**

İmza / Signature

aksa
JENERATÖR

MALIN;	
CİNSİ	JENERATÖR
MARKASI	AKSA
MODELİ / SERİ NUMARASI	
	MALIN TÜKETİCİYE TESLİM TARİHİ
	MALIN TÜKETİCİYE TESLİM YERİ
	GARANTİ / AZAMI TAMİR SÜRESİ
	2 YIL / 20 İŞGÜNÜ

İMALATÇI VEYA İTHALATÇI FİRMANIN

ÜNVANI	AKSA JENERATÖR SANAYİ ANONİM ŞİRKETİ
MERKEZ ADRESİ	RÜZGARLI BAĞÇE MAH. ÖZALP ÇIKMAZI NO:10 KAVACIK - BEYOZ - İSTANBUL / TÜRKİYE
TEL / FAX / E-MAIL	0.216 681 00 00 / 0.216 681 57 91
YETKİLİ KİŞİ / ÜNVANI	GENEL MÜDÜR
YETKİLİ KİŞİ İMZA / KAŞE	

SATICI FİRMANIN;

ÜNVANI	
ADRESİ	
TEL/FAX/ E-MAIL	
FATURA TARİHİ / NO	
YETKİLİ KİŞİ / ÜNVANI	
YETKİLİ KİŞİ İMZA / KAŞE	

GARANTİ ŞARTLARI

1. Garanti süresi, malın teslim tarihinden itibaren başlar ve tüketiciler için 2 yıldır. Malı mesleki ve ticari amaçlı olarak kullanan Tacierler(müşteri) için ise garanti süresi, firmalar arası yapılan sözleşme ile belirlenir.
2. Malın bütün parçaları dahil olmak üzere tamamını garanti kapsamıdadır.
3. Malın aygılı olduğunu anlaşılması durumunda tüketici, 6502 sayılı Tüketicinin Korunması Hakkında Kanununun 11 inci maddesinde yer alan:
 - a- Sözleşmeden dönme,
 - b- Satış bedelinden indirimi isteme,
 - c- Ücretsiz onarımını isteme,
 - ç- Satıcının ayıpsız bir misli ile değiştirilmesini isteme,hakkından birini kullanabilir.
4. Tüketicinin bu haklarından ücretsiz onarım hakkını seçmesi durumunda satıcı, işçilik masraflı, değiştirilen parça bedelî ya da başka herhangi bir ad altında hiçbir ücret talep etmeksizin malın onarımını yapmak veya yaptırmakta yükümlüdür. Tüketici, ücretsiz onarım hakkını üretici veya ithalataçya karşı da kullanabilir. Satıcı, üretici ve ithalataç tüketicinin bu hakkını kullanmasından müstesnasıyla sorumludur.
5. Tüketicinin, ücretsiz onarım hakkını kullanması halinde malın:
 - Garanti süresi içinde tekrar arızalanması,
 - Tamiri için gereken zaman süresinin aşılması,
 - Tamirini mümkün olmadığında, yetkili servis istasyonuna, yetkili servise veya malın yatacağı taraftan bir raporda belirlenmesi satıcıdan talep edebilir. Satıcı, tüketicinin talebini reddedemez. Bu talebin yerine getirilmesi durumunda satıcı, üretici ve ithalataç müteselsilen sorumludur.
6. Malın tamiri süresi 20 iş gününü geçemez. Bu süre, garanti süresi içerisinde mala ilişkin arızanın yetkili servis istasyonuna veya satıcıya bildirimini tarihinde, garanti süresi dışında ise malın yetkili servis istasyonuna teslim tarihinden itibaren başlar. Malın arızasının 10 iş günü içerisinde giderilmesi halinde, üretici veya ithalataç malın tamiri tamamlandıncaya kadar, benzer özelliklere sahip başka bir malı tüketicinin kullanımına tabii kullanıma kılavzunda yer alan hususlara aykırı kullanımasından kaynaklanan arızalar garanti kapsamı dışındadır.
7. Malın kullanıma kılavzunda yer alan hususlara aykırı kullanımasından kaynaklanan arızalar garanti kapsamı dışındadır.
8. Tüketici, garantiden doğan haklarının kullanılmasını ile ilgili olarak çıkabilecek uyarımsızlıklarda yerleşim yerinin bulunduğu veya tüketici işleminin yapıldığı yerdeki Tüketici Hakem Heyetince veya Tüketici Halkemnesine başvurabilir.
9. Satıcı tarafından bu Garanti Belgesinin verilmesi durumunda, tüketici Gümrük ve Ticaret Bakanlığı Tüketicinin Korunması ve Piyasa Gözetimi Genel Müdürlüğüne başvurabilir.

Not: Servisin Müddetleesi sırasında müşteri tarafından bu belge veya fatura ibraz edilmek zorundadır.

GARANTİ DIŞI DURUMLAR

1. Satın alınan jeneratörlerin devreye alma işlemleri AKSA Jeneratör yetkili servislerince yapılmalı, müşterinin kendisi veya başka bir servise yaptırılmamalıdır. Aksi durumda Jeneratör garantisi kapsamı dışına çıkar. Yapılan devreye alma işlemleri, sadece işlemin yapıldığı mekân için geçerli olup, yani bir yerde kullanımı için tekrar AKSA Jeneratör yetkili servislerince devreye alınmalıdır. İkinci defa yapılacak devreye alma işleminin ücretini müşteri karşılayacaktır.
2. Garanti süresi içerisindeki bütün jeneratörlerimizin, periyodik bakım çizelgesinde belirtilen tüm bakımları, Akso Jeneratörün yetkili servislerine ücretli karşılığında yaptırılmıdır. Bu bakımlardan herhangi birisinin yapılması durumunda jeneratör garantisi kapsamı dışına çıkar.
3. AKSA Jeneratör tarafından onaylanmayan malzeme kullanımı sonucu gerçekleşen arızalar, ihmal sonucu oluşan arızalar, yanlış kullanıma, uygun olmayan güçte kullanıma, yanlış yerleşim, uygun olmayan senarlarıdaki depolama durumlarından kaynaklanacak arızalarda ve yetkili olmayan servisler ve şahıslar tarafından tamiri, bakım veya müdahalelerde jeneratör garantisi kapsamı dışına çıkar.
4. Satın alınan jeneratör 6 ay içerisinde devreye alınmayacaksa, jeneratöre ait depolama koşulları sağlanmak kaydı ile bekletilmelidir. Garanti süresi içerisindeki bir makinenin depolama (konservasyon) işlemini yaptırılması durumunda jeneratör garantisi kapsamı dışına çıkar.
5. Kamyon üsü teslimlerde, nakliye sorumluluğu, indirme sorumluluğu da dahil olmak üzere kamyon üstünde tesliminden sonra, start işlemine kadar makinenin uygun senarlarda muhafaza edilmesi tamamen müşterinin sorumluluğu almaktadır. Bu esnada oluşacak hasar ve arızalarda jeneratör garantisi kapsamı dışına çıkar.
6. Soğutma sistemine, silindir gömleği veya bloğunda karncıklanma, erozyon ve tortu oluşması için eklenmesi gereken kimyasalların eklenmesi durumunda, oluşan arızalarda jeneratör garantisi kapsamı dışına çıkar.
7. Satın alınan jeneratörlere garanti süresi içerisinde, orijinal ekipmanları ve projesi haricinde senkron, ilave kontrol ünitesi, pano, transfer pano vb. ilave ekipman veya proje yapılamaz. Akso Jeneratörün onayı olmadan yapılmış jeneratör garantisi kapsamı dışına çıkar.
8. Deprem, sel, su baskını, yıldırım düşmesi ve benzeri doğal afetler gibi çevresel etkilere den ve sebebeden kaynaklanan arızalarda jeneratör garantisi kapsamı dışına çıkar.
9. Jeneratör gücüne uygun seçilen sebekte kontaklıtı üzerinde, jeneratör nominal dikimından fazla akım çekilmesinden kaynaklanacak sebekte kontaklıtı, safı redresörü ve ısıtıcı gibi ünitelerde oluşacak arızalarda Akso Jeneratör sorumlu değildir.
10. Kullanılan yakıt, yağ ve soğutma suyu kullanıma kitapçaklarında verilen özelliklere sahip olmalıdır. Aksi halde oluşacak arıza ve hasarlarda jeneratör garantisi kapsamı dışına çıkar.
11. Jeneratör uzun süre çalışmazsa aküsü boşalabilir. Motorun yağlanması, uzun ömürlü olması ve akünün sarılı için jeneratörün haftada 1 gün çalıştırılması gerekmektedir. Aksi halde oluşacak arızalarda jeneratör garantisi kapsamı dışına çıkar.

Head Office

TURKEY
Rüzgarlı Bahçe Mah.
Selvi Çıkması No:10, 34805
Kavacak, Beykoz - İstanbul
T : + 90 216 681 00 00
E : aksa@aksa.com.tr

Aksa Service

TURKEY
Murat Bey Beldesi,
Güney girişi Cad. No:8
34540 Çatalca / İSTANBUL
T : +90 212 887 11 11
E : info@aksaservis.com.tr

Aksa Rental

TURKEY
Murat Bey Beldesi,
Güney girişi Cad. No:8
34540 Çatalca / İSTANBUL
T : +90 212 887 12 12
E : aksakiralama@aksakiralama.com.tr

U.A.E.
Aksa Middle East
Post Box. No:18167 Jebel ali Free Zone
Dubai - United Arab Emirates
T : +971 4 880 91 40
E : sales@aksa.ae

Factories

TURKEY
Yıldırım Beyazıt Osb Mh.
8. Cd. No:1/2/A - 1/3A, 59850 Tekirdağ
T : + 90 282 737 96 00
E : aksa@aksa.com.tr

CHINA
No.19 Tongjiang North Road,
New District, Changzhou / China
T : + 86 (0) 519 856 01 250
E : aksa@aksapowergen.com

USA
371 Exchange Street
West Monroe, LA 71292
T : +1 318 855 83 77
E : sales@aksausa.com

NETHERLANDS
Merwedestraat 48P 3313CS,
Dordrecht/Netherlands
T : +31 (0) 78-204 9129
E : sales@aksaeurope.com